

30 03 500, Motorbesturingskast Tanner MDC 100/200/300, 230V

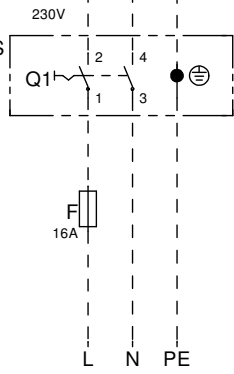

Voeding
1~230V + N + PE

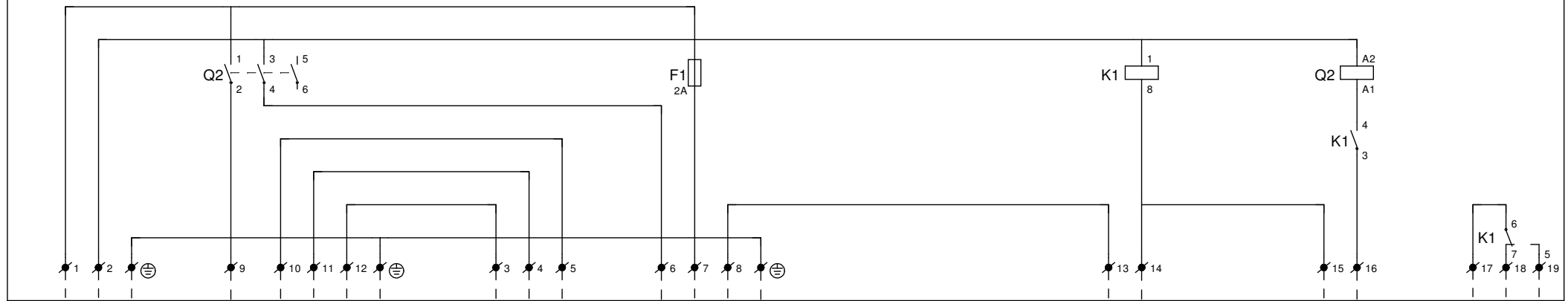
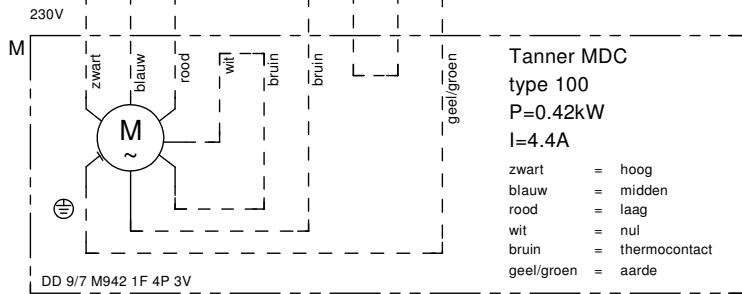
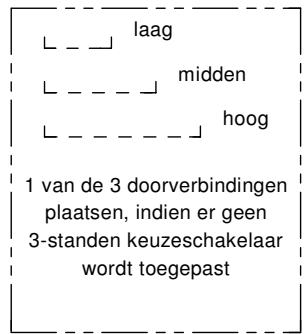
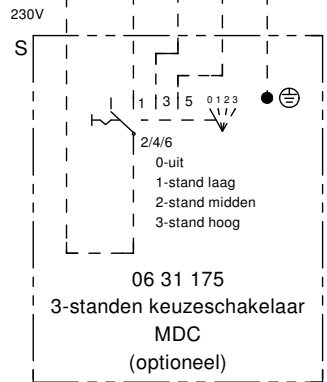

Tanner MDC
type 100
P=0.42kW
I=4.4A

zwart = hoog
blauw = midden
rood = laag
wit = nul
bruin = thermocontact
geel/groen = aarde

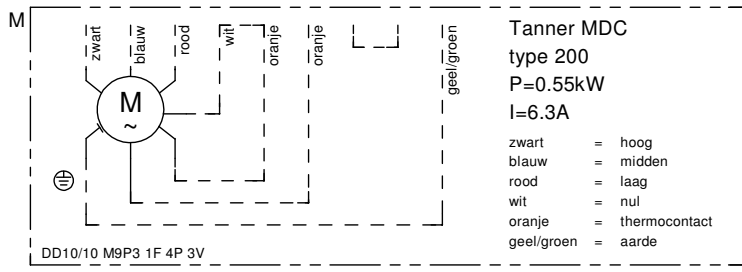

Tanner MDC
type 200
P=0.55kW
I=6.3A

zwart = hoog
blauw = midden
rood = laag
wit = nul
oranje = thermocontact
geel/groen = aarde

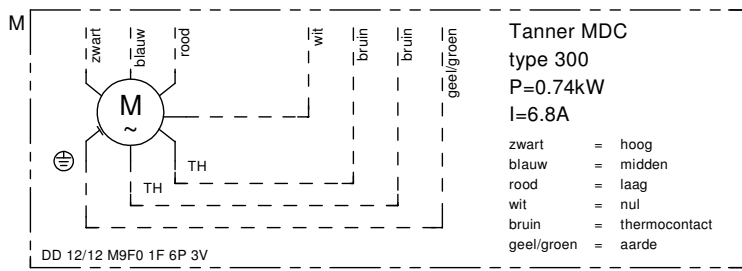

Tanner MDC
type 300
P=0.74kW
I=6.8A

zwart = hoog
blauw = midden
rood = laag
wit = nul
bruin = thermocontact
geel/groen = aarde

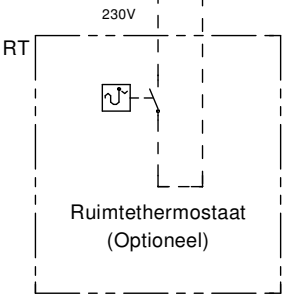

Ruimtethermostaat
(Optioneel)

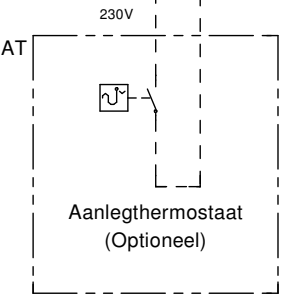

Aanlegthermostaat
(Optioneel)

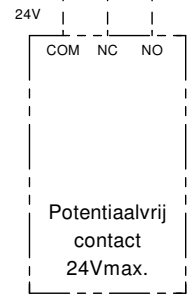
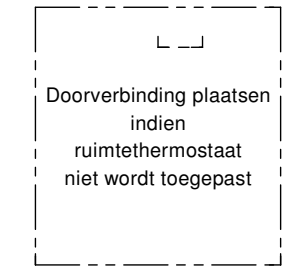

Potentiaalvrij
contact
24Vmax.

WS - 06 31 162 Werkschakelaar