

Motor control panel Tanner MDC 400, 3~400V

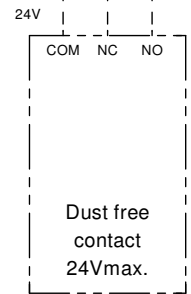
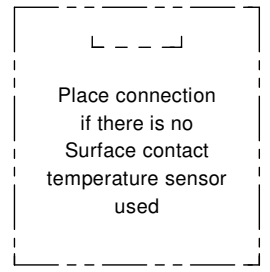
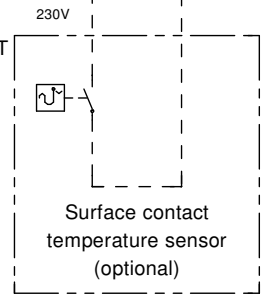
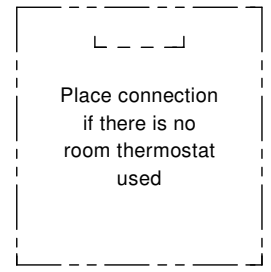
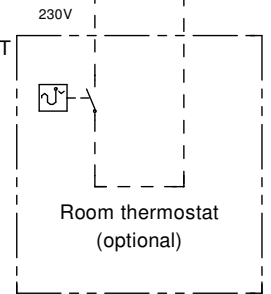
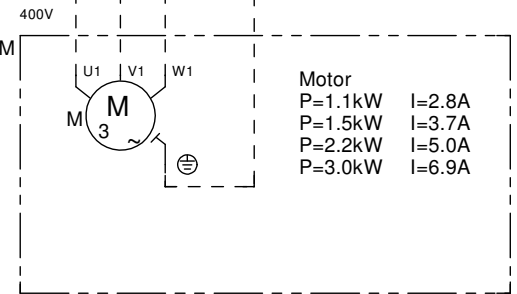
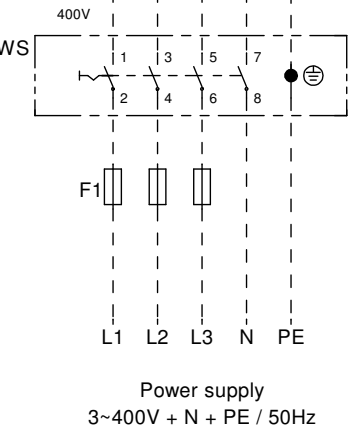
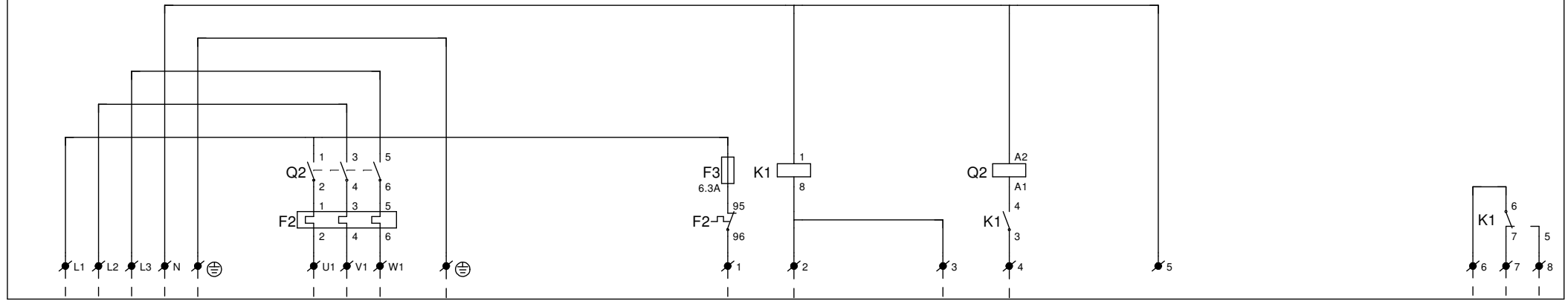

Motor control panel MDC 3~400V					
codenr.	Motor type		Thermal protection (F2)		Fuse (F1)
30.03.502	P= 1.1kW	I= 2.8A	06.32.174	2.7-4.0A	F= 10A
30.03.503	P= 1.5kW	I= 3.7A	06.32.174	2.7-4.0A	F= 16A
30.03.504	P= 2.2kW	I= 5.0A	06.32.175	4.0-6.0A	F= 16A
30.03.505	P= 3.0kW	I= 6.9A	06.32.176	6.0-9.0A	F= 20A

WS - Isolator switch