

CALFLO

Gas-fired make-up air heater

Air heater with burner located directly in the air flow.
Output from 64 to 896 kW.



For more information,
downloads and
videos, visit the Calflo
page on our website



Maximum performance with large air quantities

The Mark CALFLO is a make up air heating system. This means that the burner (and the flame) is located directly in the air flow to deliver maximum performance. The flue gases are so clean that they may be blown into the building. The CALFLO is suitable for rooms requiring large degrees of ventilation. This appliance is equipped with a modulating stainless steel burner and a seawater-resistant aluminium housing.

Possible applications include sand blasting areas, welding areas, and the processing industry.

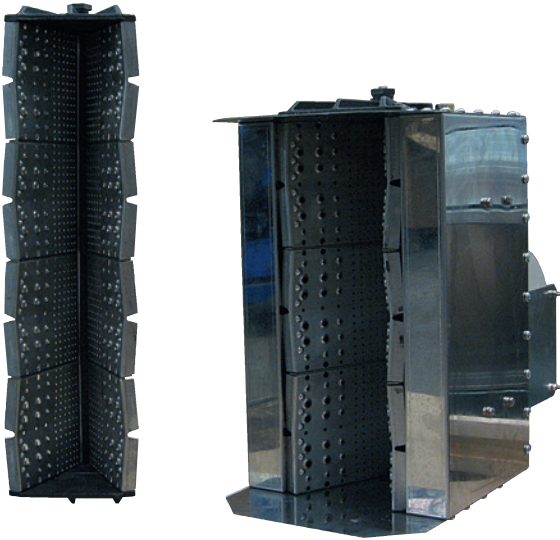

Product features

- Stainless steel line or box burners
- AlMg3 seawater-resistant aluminium housing (single-skin or double-skin)
- Low weight
- Available for both inside and outside installation
- Large air displacement
- Wide turndown ratio through use of modulating burner
- Long lifespan
- Extensive configuration options
- Reliable
- HT filters (option)



Dimensions

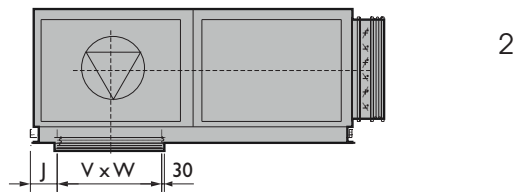
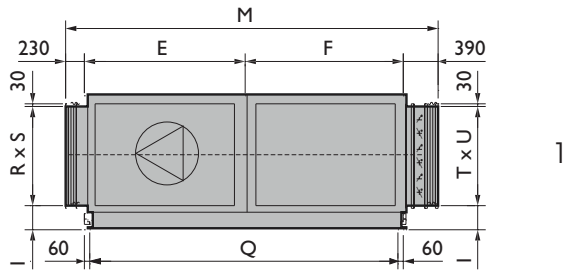
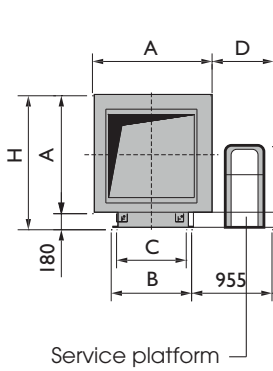

1-4: Indoor version
 5&6: External installation

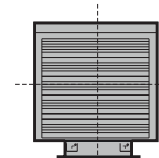
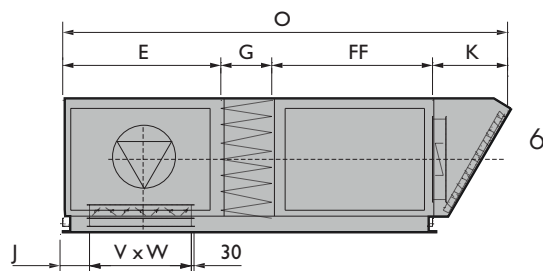
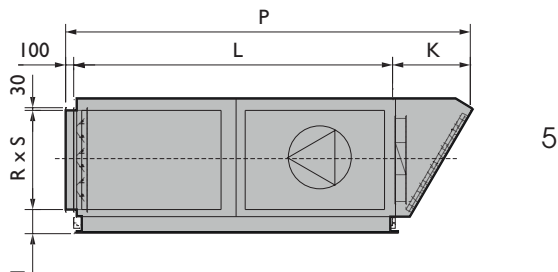
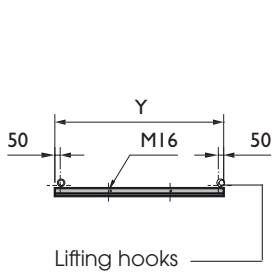
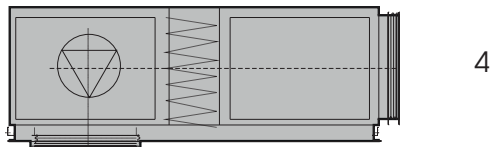
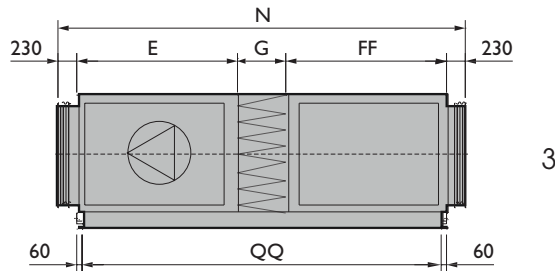



This table belongs to the previous page

Type	A	B	C	D	E	F	FF	G	H	I	J	K	L	M	N	O	P	Q	QQ	RxS	TxU	VxW	Y
55CK55	1090	870	750	845	1090	1090	1680	590	1270	295	160	745	2180	2800	3820	4105	3025	2040	3220	860x820	1025x1020	820x530	1400
55CK35	1090	870	750	845	1090	1090	1680	590	1270	295	160	745	2180	2800	3820	4105	3025	2040	3220	860x820	1025x1020	820x530	1400
110CK55	1090	870	750	845	1090	1090	1680	590	1270	295	160	745	2180	2800	3820	4105	3025	2040	3220	860x820	1025x1020	820x530	1400
110CK35	1090	870	750	845	1090	1090	1680	590	1270	295	160	745	2180	2800	3820	4105	3025	2040	3220	860x820	1025x1020	820x530	1400
165CK55	1404	960	840	733	1900	1900	1900	600	1584	287	340	915	3800	4420	4860	5315	4815	3680	4280	1190x1220	1190x1220	1220x695	2000
165CK35	1404	960	840	733	1900	1900	1900	600	1584	287	340	915	3800	4420	4860	5315	4815	3680	4280	1190x1220	1190x1220	1220x695	2000
220CK55	1404	960	840	733	1900	1900	1900	600	1584	287	340	915	3800	4420	4860	5315	4815	3680	4280	1190x1220	1190x1220	1220x695	2000
220CK35	1404	960	840	733	1900	1900	1900	600	1584	287	340	915	3800	4420	4860	5315	4815	3680	4280	1190x1220	1190x1220	1220x695	2000
275CK55	1404	960	840	733	1900	1900	1900	600	1584	287	340	915	3800	4420	4860	5315	4815	3680	4280	1190x1220	1190x1220	1220x695	2000
275CK35	1804	1370	1250	738	1900	1900	1900	600	1984	405	240	1165	3800	4420	4860	5565	5065	3680	4280	1355x1420	1685x1620	1420x1025	2400
330CK55	1804	1370	1250	738	1900	1900	1900	600	1984	405	240	1165	3800	4420	4860	5565	5065	3680	4280	1355x1420	1685x1620	1420x1025	2400
330CK35	1804	1370	1250	738	1900	1900	1900	600	1984	405	240	1165	3800	4420	4860	5565	5065	3680	4280	1355x1420	1685x1620	1420x1025	2400
385CK55	1804	1370	1250	738	1900	1900	1900	600	1984	405	240	1165	3800	4420	4860	5565	5065	3680	4280	1355x1420	1685x1620	1420x1025	2400
385CK35	1804	1370	1250	738	1900	1900	1900	600	1984	405	240	1165	3800	4420	4860	5565	5065	3680	4280	1355x1420	1685x1620	1420x1025	2400
440CK55	1804	1370	1250	738	1900	1900	1900	600	1984	405	240	1165	3800	4420	4860	5565	5065	3680	4280	1355x1420	1685x1620	1420x1025	2400
495CK55	1804	1370	1250	738	1900	1900	1900	600	1984	405	240	1165	3800	4420	4860	5565	5065	3680	4280	1355x1420	1685x1620	1420x1025	2400
440CK35	2204	1810	1690	758	2200	2200	2200	600	2384	357	190	1280	4400	5020	5460	6280	5780	4280	4880	1850x1820	2015x2020	1820x1355	2800
495CK35	2204	1810	1690	758	2200	2200	2200	600	2384	357	190	1280	4400	5020	5460	6280	5780	4280	4880	1850x1820	2015x2020	1820x1355	2800
550CK55	2204	1810	1690	758	2200	2200	2200	600	2384	357	190	1280	4400	5020	5460	6280	5780	4280	4880	1850x1820	2015x2020	1820x1355	2800
550CK35	2204	1810	1690	758	2200	2200	2200	600	2384	357	190	1280	4400	5020	5460	6280	5780	4280	4880	1850x1820	2015x2020	1820x1355	2800
660CK55	2204	1810	1690	758	2200	2200	2200	600	2384	357	190	1280	4400	5020	5460	6280	5780	4280	4880	1850x1820	2015x2020	1820x1355	2800
660CK35	2204	1810	1690	758	2200	2200	2200	600	2384	357	190	1280	4400	5020	5460	6280	5780	4280	4880	1850x1820	2015x2020	1820x1355	2800
770CK55	2204	1810	1690	758	2200	2200	2200	600	2384	357	190	1280	4400	5020	5460	6280	5780	4280	4880	1850x1820	2015x2020	1820x1355	2800
770CK35	2204	1810	1690	758	2200	2200	2200	600	2384	357	190	1280	4400	5020	5460	6280	5780	4280	4880	1850x1820	2015x2020	1820x1355	2800

Technical information

Type		55	110	165	220	275	330	385	440	495	550	660	770
Nominal load (upper value)	kW	71	142	213	284	356	427	498	569	640	712	854	996
Nominal load (lower value)	kW	64	128	192	256	320	384	448	512	576	640	768	896
Minimum load (lower value)	kW	3,2	6,4	9,6	12,8	16,0	19,2	22,4	25,6	28,8	32,0	38,4	44,8
Burner turndown ratio		20:1	20:1	20:1	20:1	20:1	20:1	20:1	20:1	20:1	20:1	20:1	20:1
Gas consumption G20 (15°C)	m³/h	7,9	15,8	23,6	31,5	39,4	47,3	55,1	63,0	70,9	78,8	94,5	110,3
Gas consumption G25 (15°C)	m³/h	6,8	13,5	20,3	27,1	33,9	40,6	47,4	54,2	60,9	67,7	81,3	94,8
Gas consumption G31 (15°C)	kg/h	5,0	9,9	14,9	19,9	24,8	29,8	34,8	39,7	44,7	49,7	59,6	69,5
Gas consumption G30 (15°C)	kg/h	5,1	10,1	15,2	20,2	25,3	30,3	35,4	40,4	45,5	50,5	60,6	70,7
Air displacement ΔT35K (15°C)	m³/h	5430	10870	16300	21740	27170	32600	38040	43470	48900	54340	65200	76080
Fan type ΔT35K		355	450	560	560	710	710	710	900	900	900	900	1000
Air displacement ΔT55K (15°C)	m³/h	3500	7020	10450	14130	17510	20800	24350	27820	31210	34730	41680	48700
Fan type ΔT55K		355	450	560	560	560	710	710	710	710	900	900	900



Assembly/location suggestions

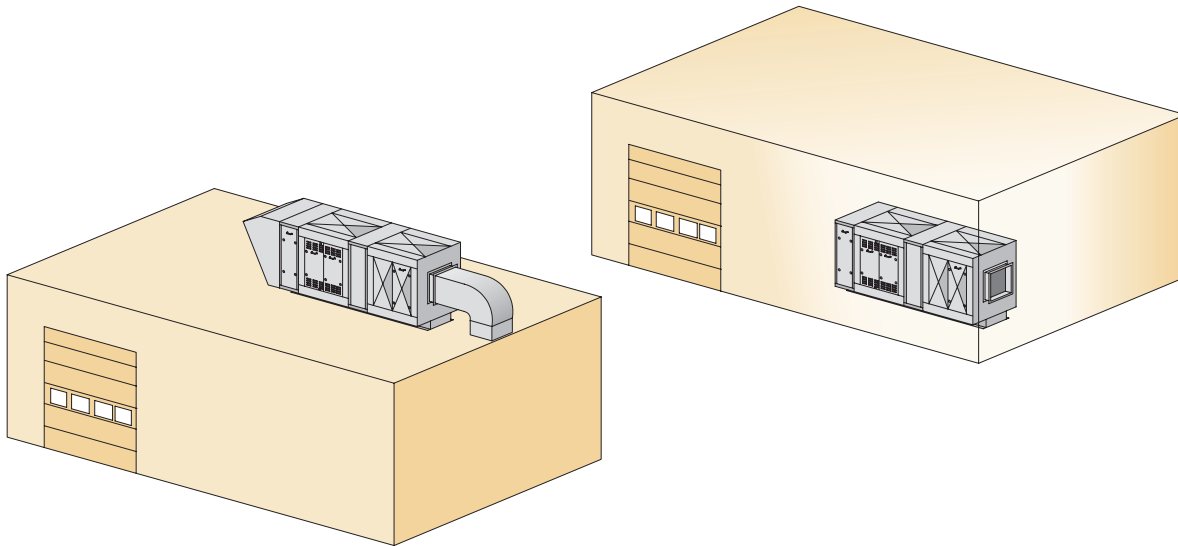

Controls

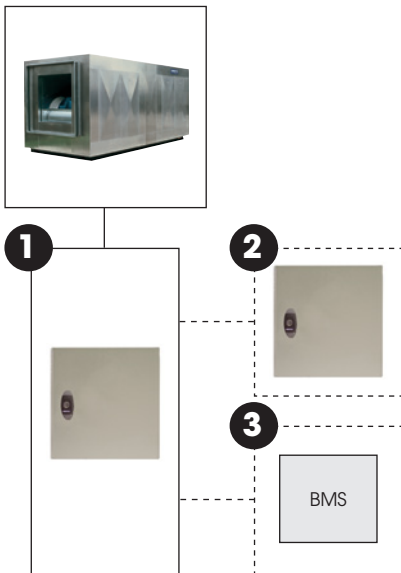

Control combination options

Calflo	+	1		
Calflo on/off or high/low	+	1	+	2
Calflo on/off or high/low	+	1	+	3

- 1 = Motor control box
- 2 = Remote control C10 CALFLO on/off
Remote control C12 CALFLO on/off with clock
Remote control C20 CALFLO high/low
Remote control C22 CALFLO high/low with clock